

RS VI

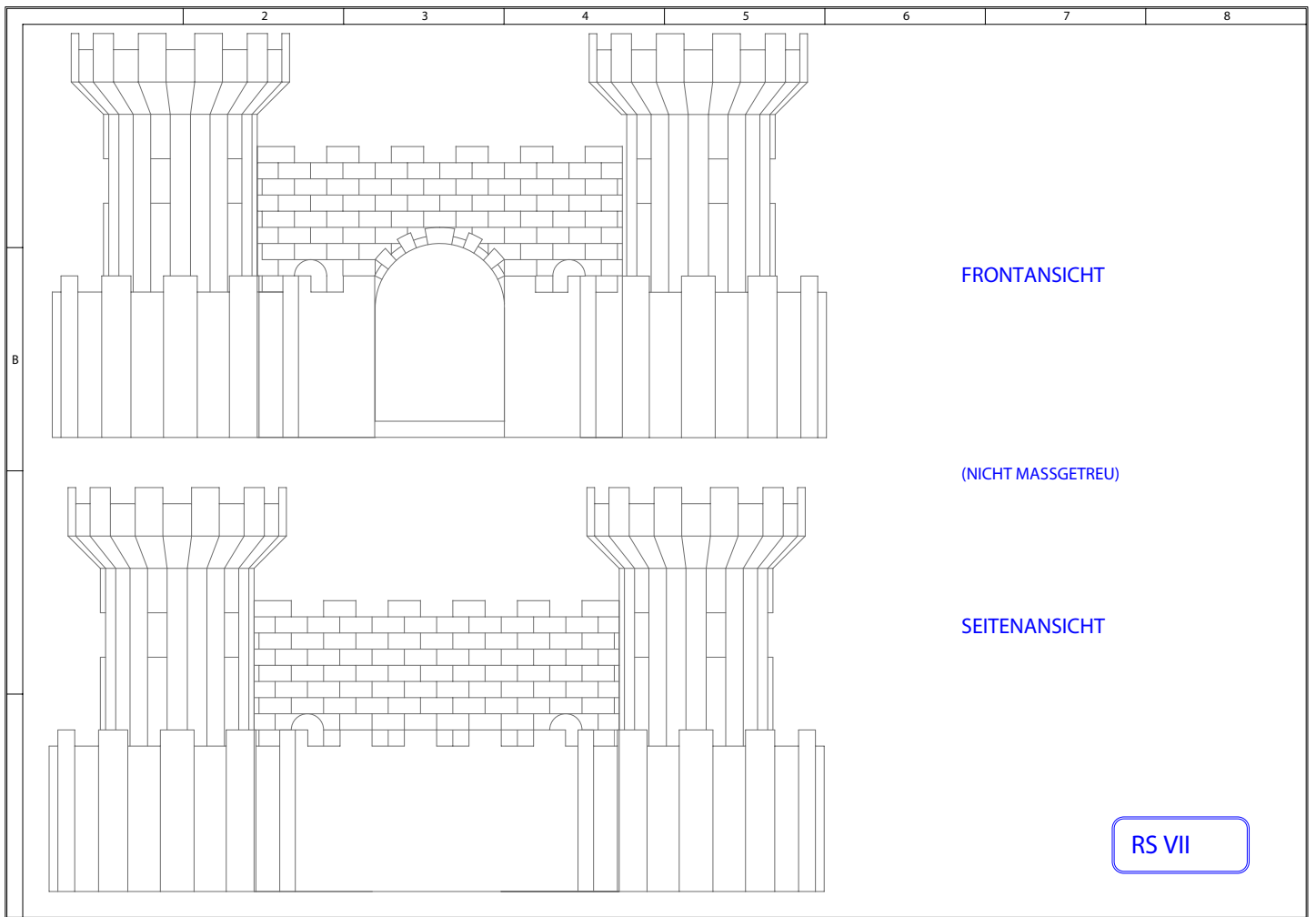

FRONTANSICHT

(NICHT MASSGETREU)

SEITENANSICHT

RS VII

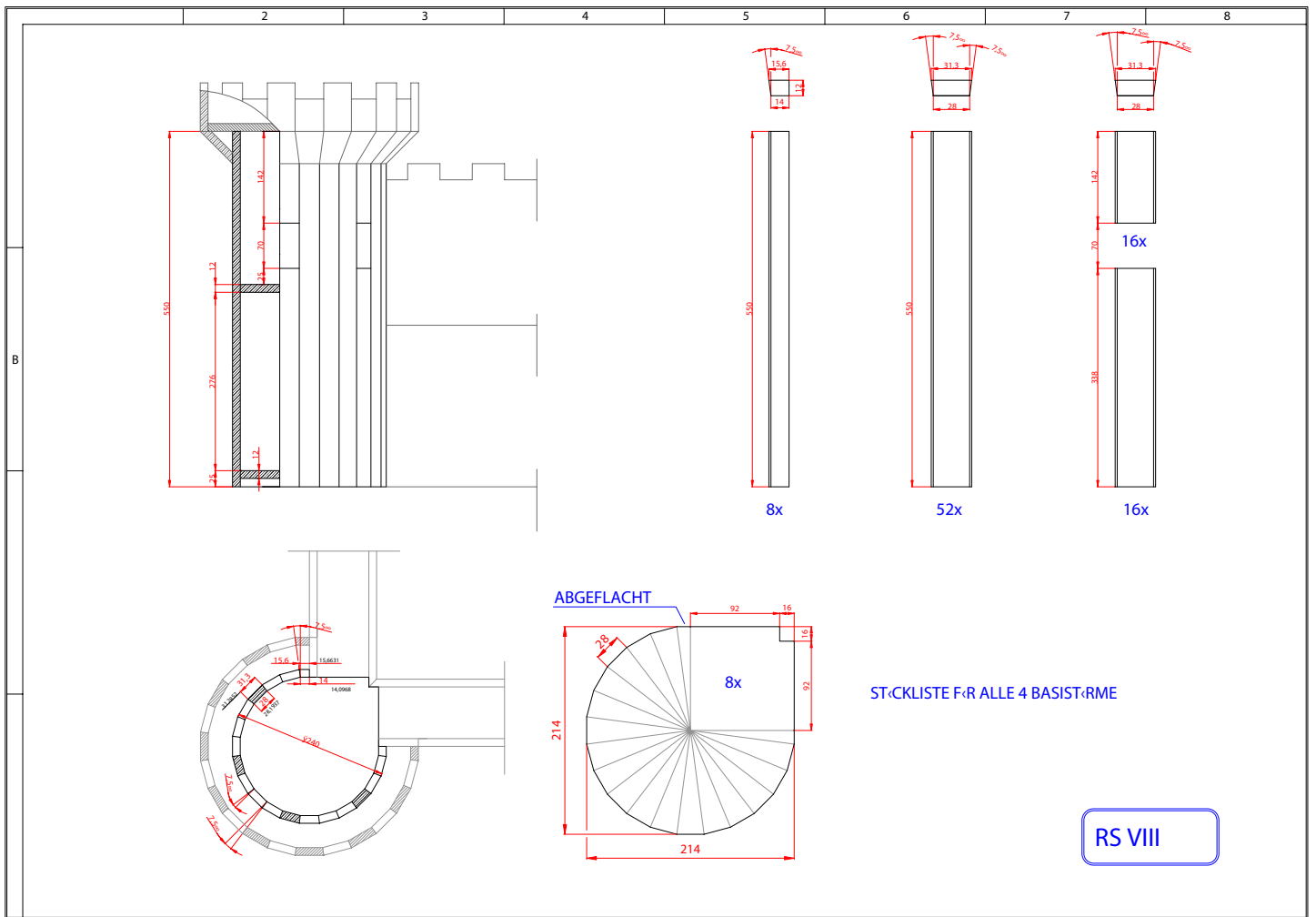



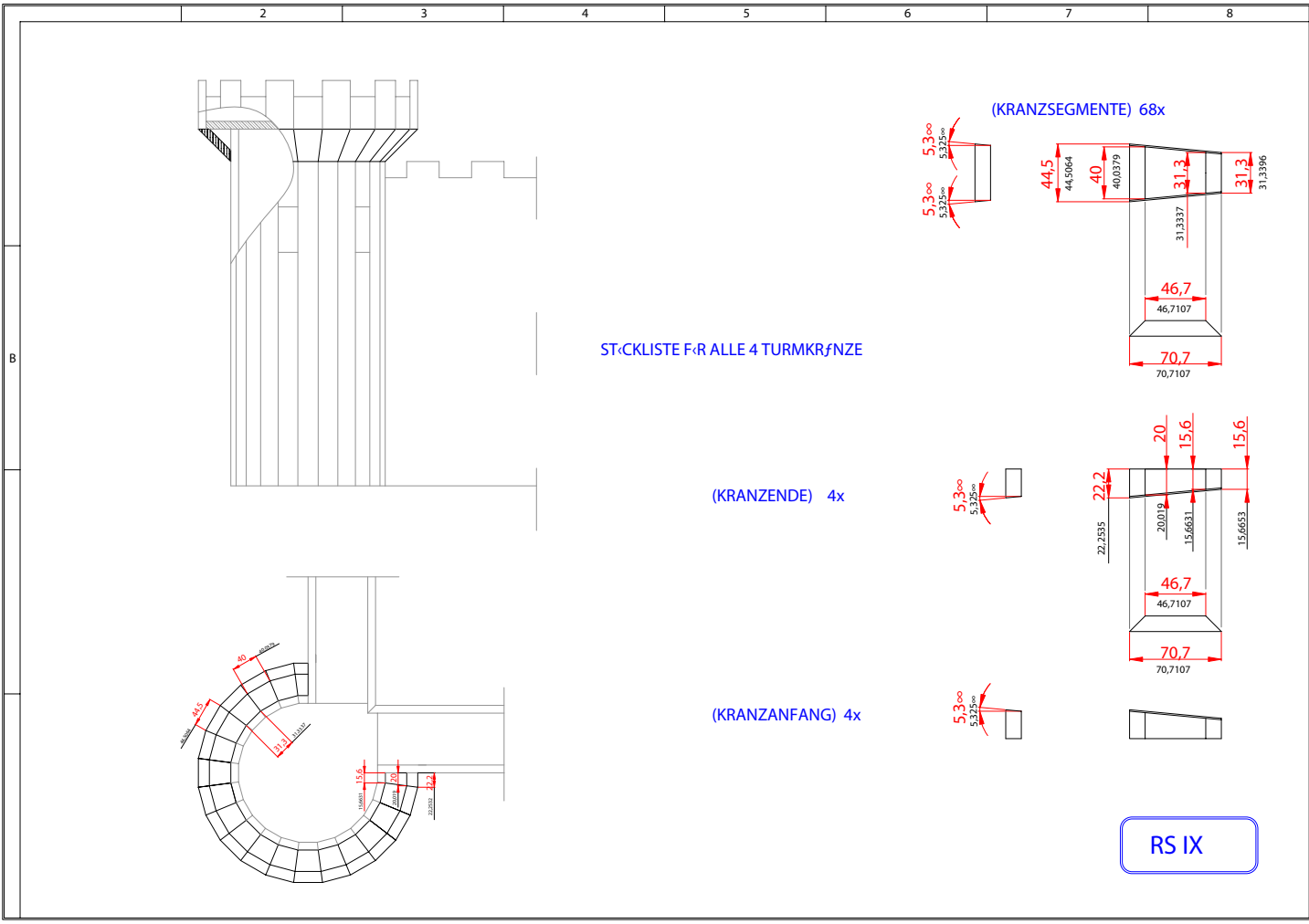

B

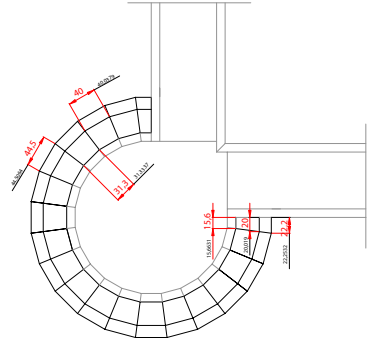
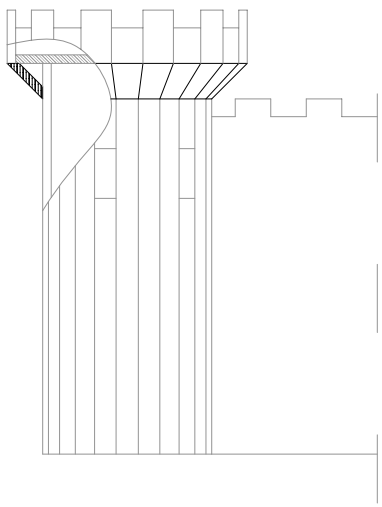

STÜCKLISTE FÜR ALLE 4 TURMKRÄNZE

(KRANZENDE) 4x

(KRANZANFANG) 4x

(KRANZSEGMENTE) 68x

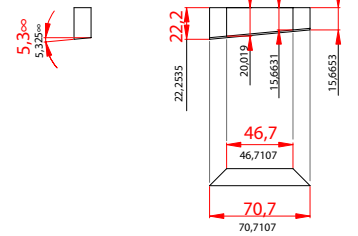
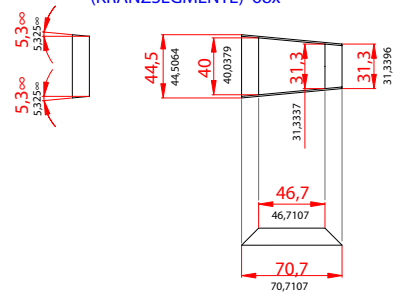

RS IX

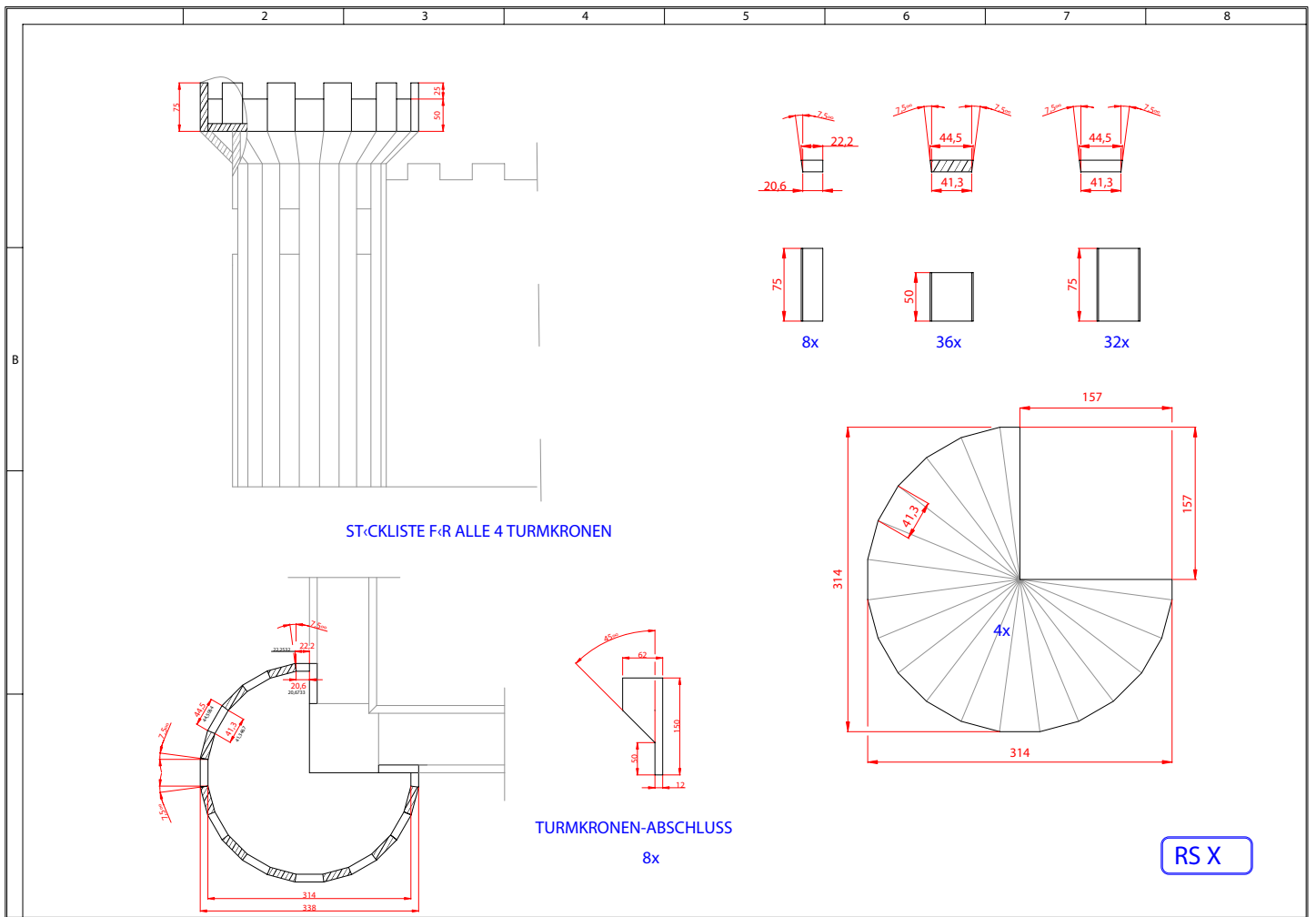

RS X

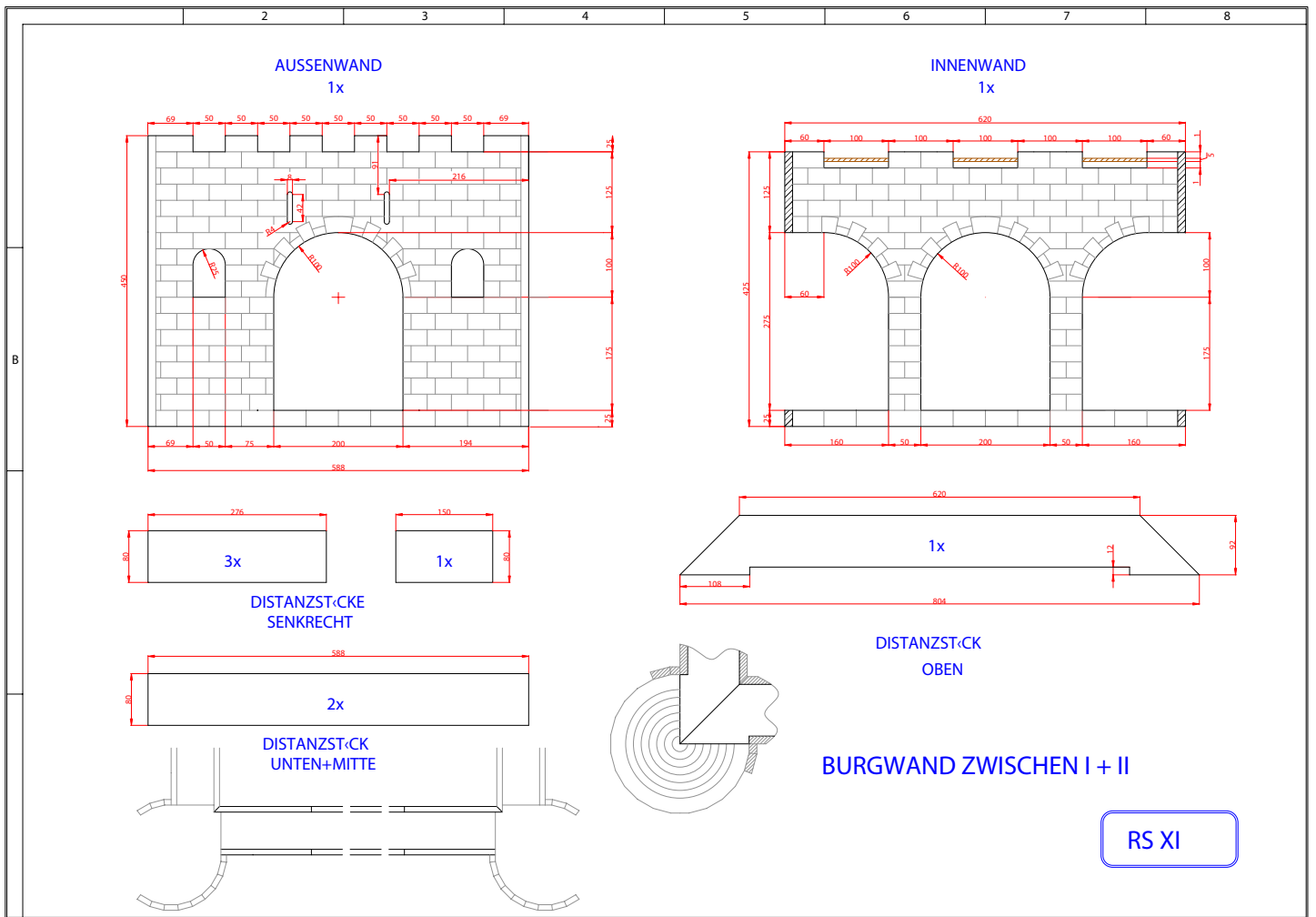

AUSSENWAND  
3x

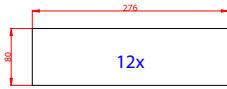
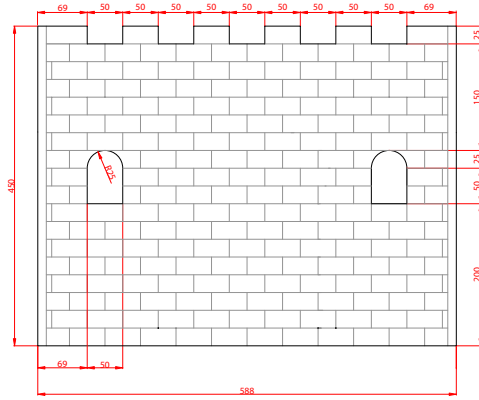

DISTANZST-CK  
SENKRECHT

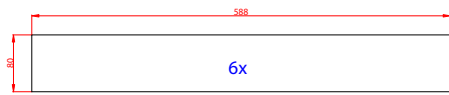

DISTANZST-CK  
UNTEN+MITTE

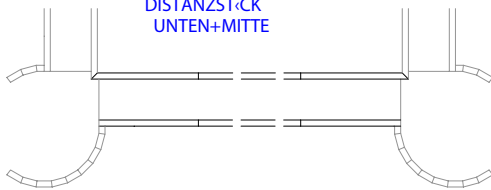

INNENWAND  
3x

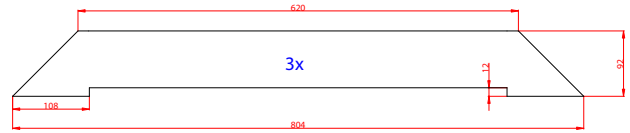
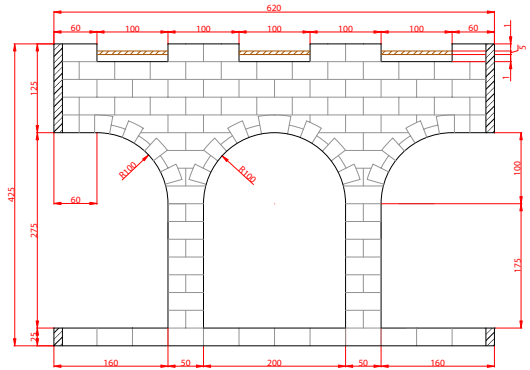

DISTANZST-CK  
OBEN

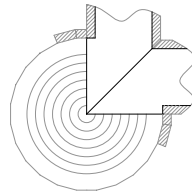

BURGWÄNDE II>III>IV>I

RS XII

AUSSENWAND

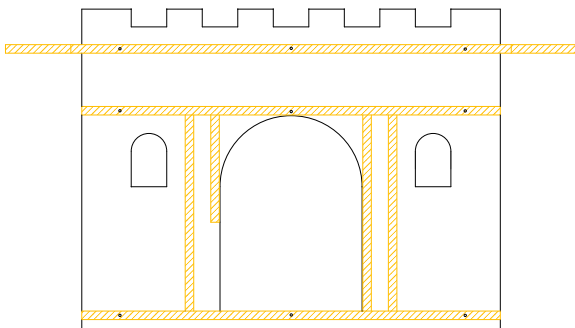

INNENWAND

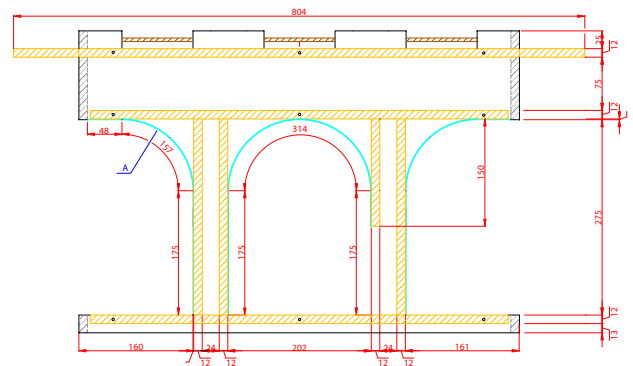

DISTANZSTÜCK

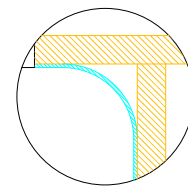
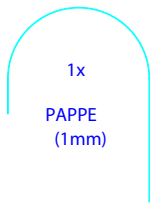

DETAIL A

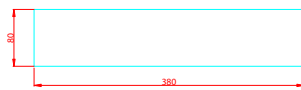

MONTAGE BURGWAND I > II

RS XIII

AUSSENWAND

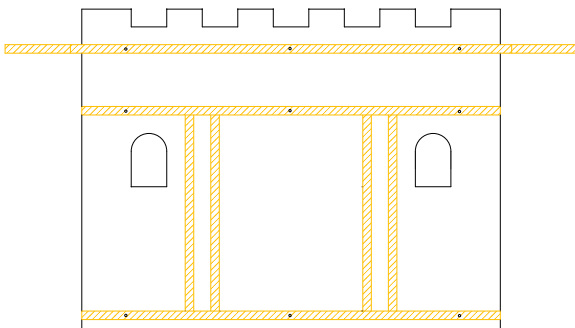

INNENWAND

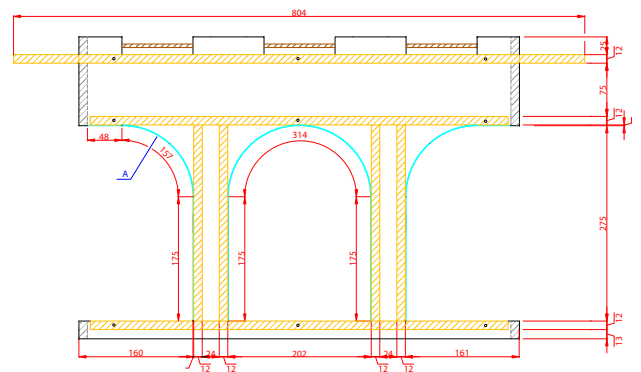

3x  
PAPPE  
(1mm)



6x  
PAPPE  
(1mm)

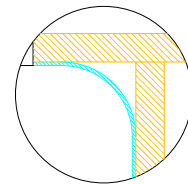
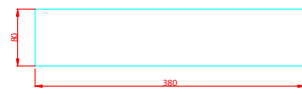

DETAIL A

MONTAGE BURGWfNDE II>III>IV>I

RS XIV

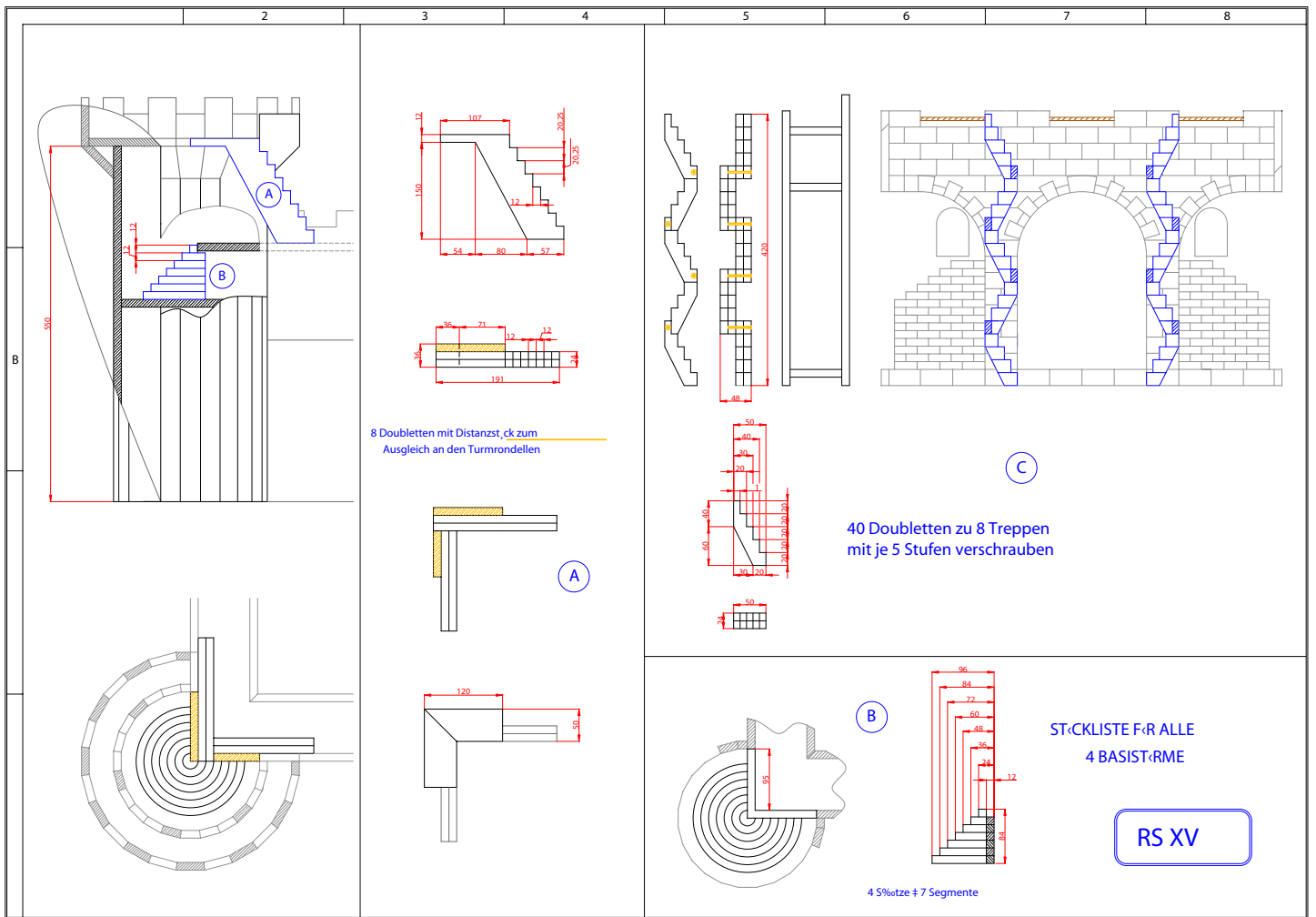

TREPPENAUFGANGE ZU DEN  
BURGWALL-TOREN

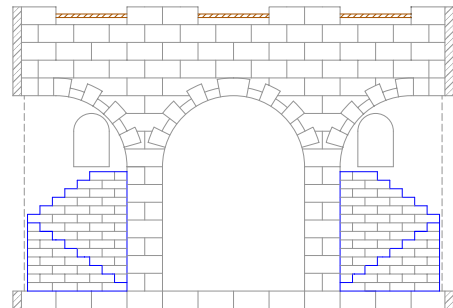
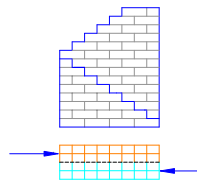
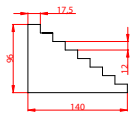
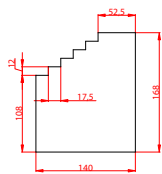

8 TREPPENBLÖCKE

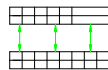

DIE 16 DOUBLETEN PAARWEISE  
ZUM TREPPENBLOCK ZUSAMMENKLEBEN

RS XVI



